

**COUPE AA**  
Echelle: 1/50

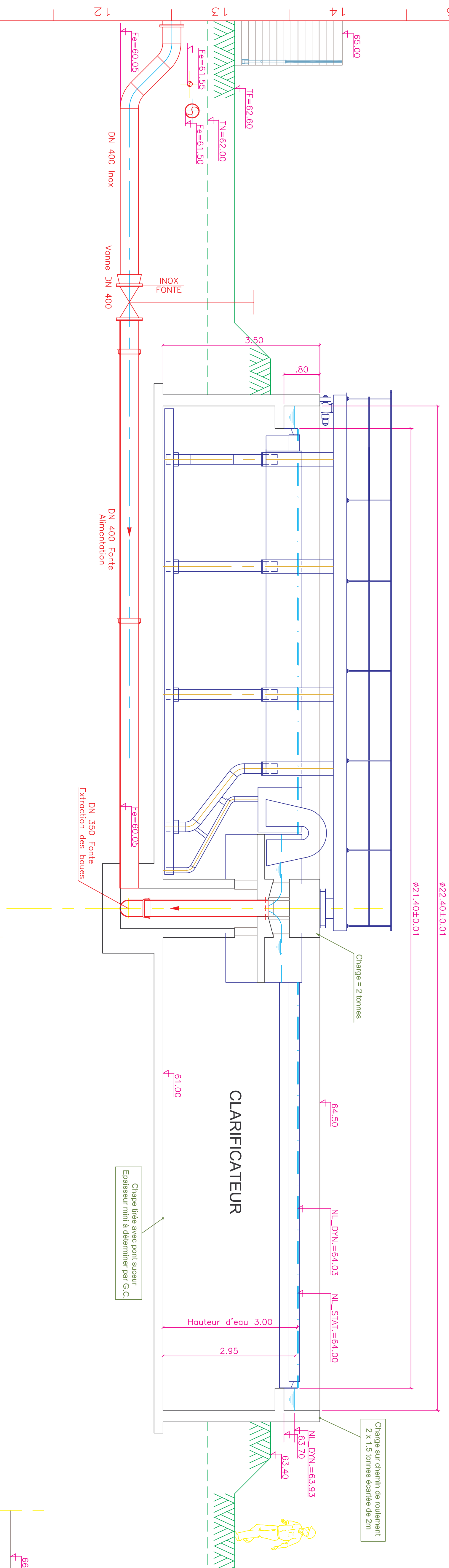

**COUPE BB**  
Echelle: 1/25

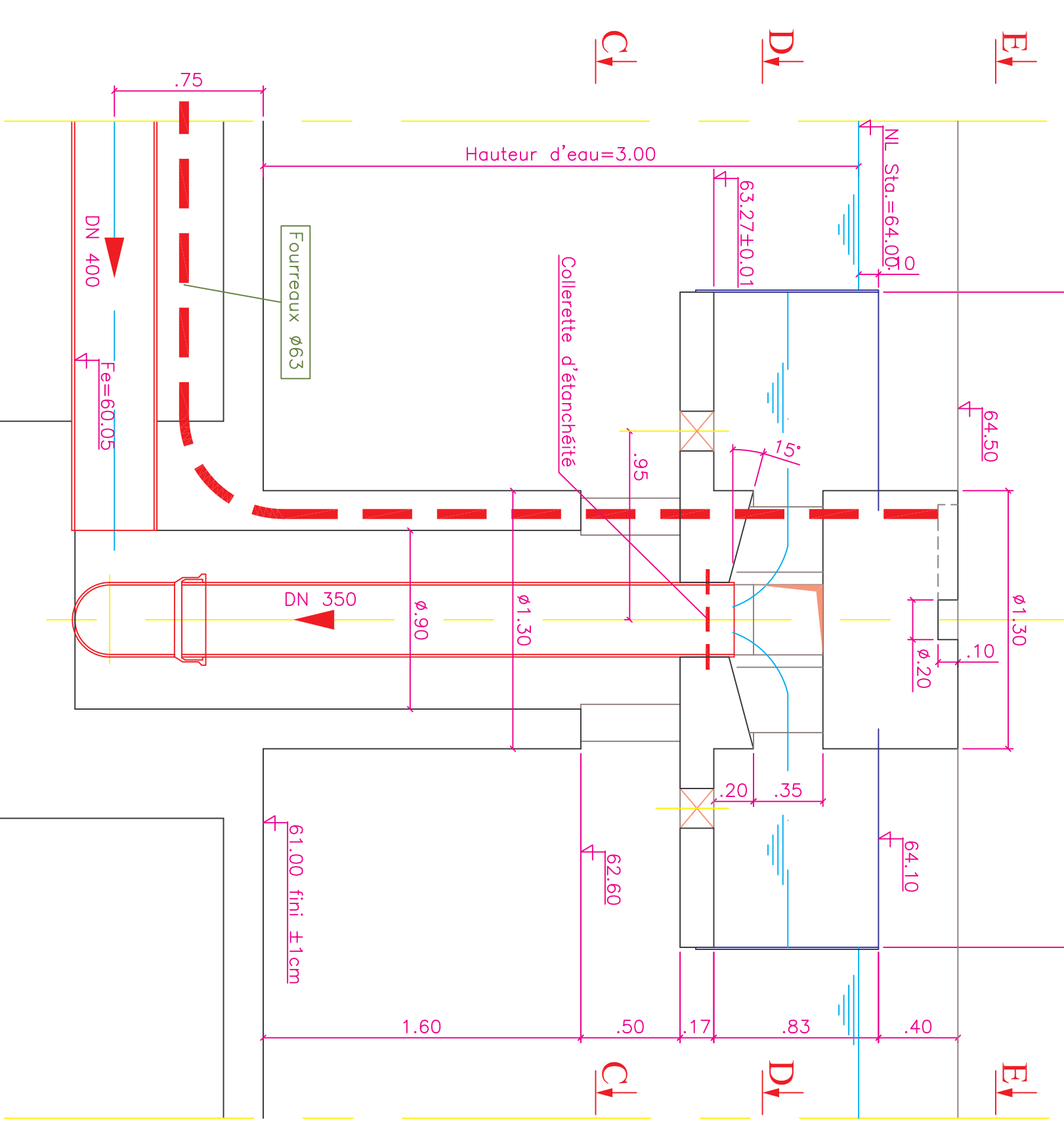

**COUPE CC**  
Echelle: 1/25

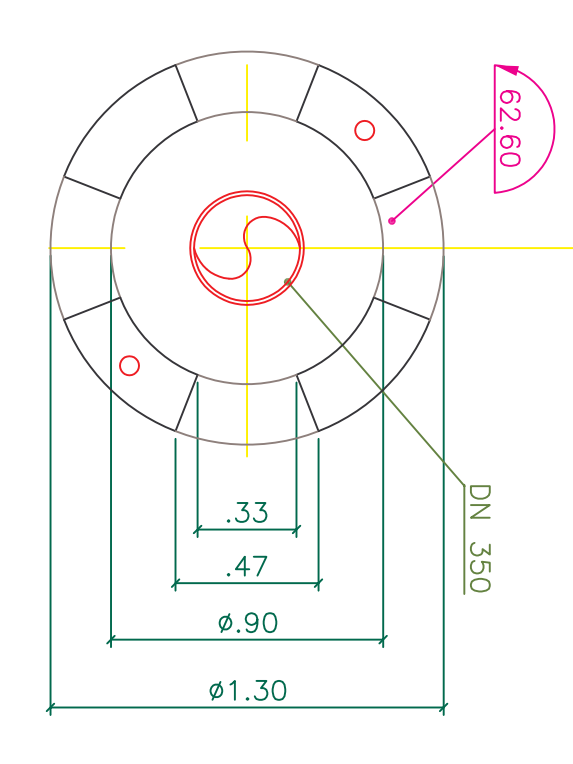

**COUPE DD**  
Echelle: 1/25

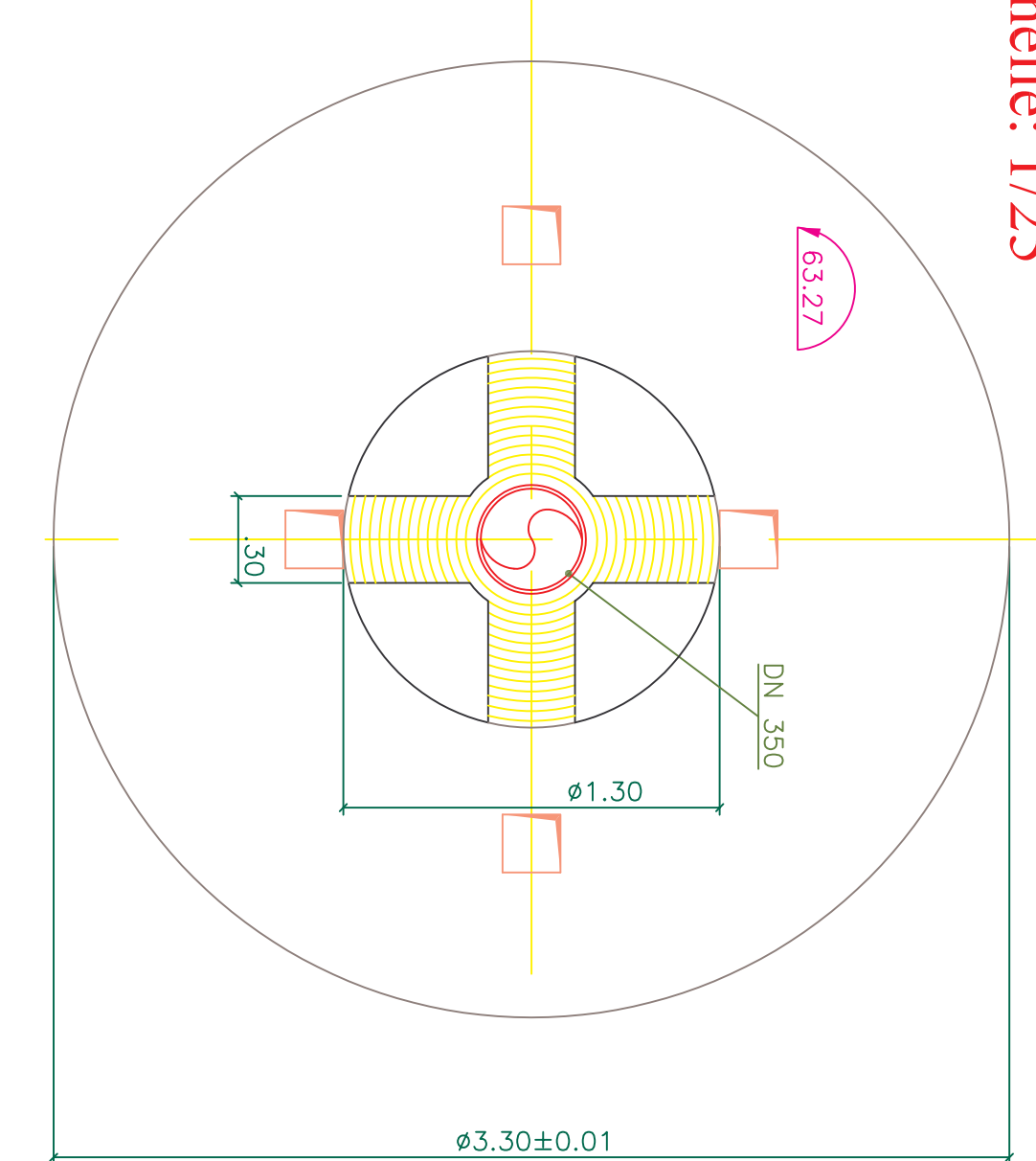

**COUPE EE**  
Echelle: 1/25

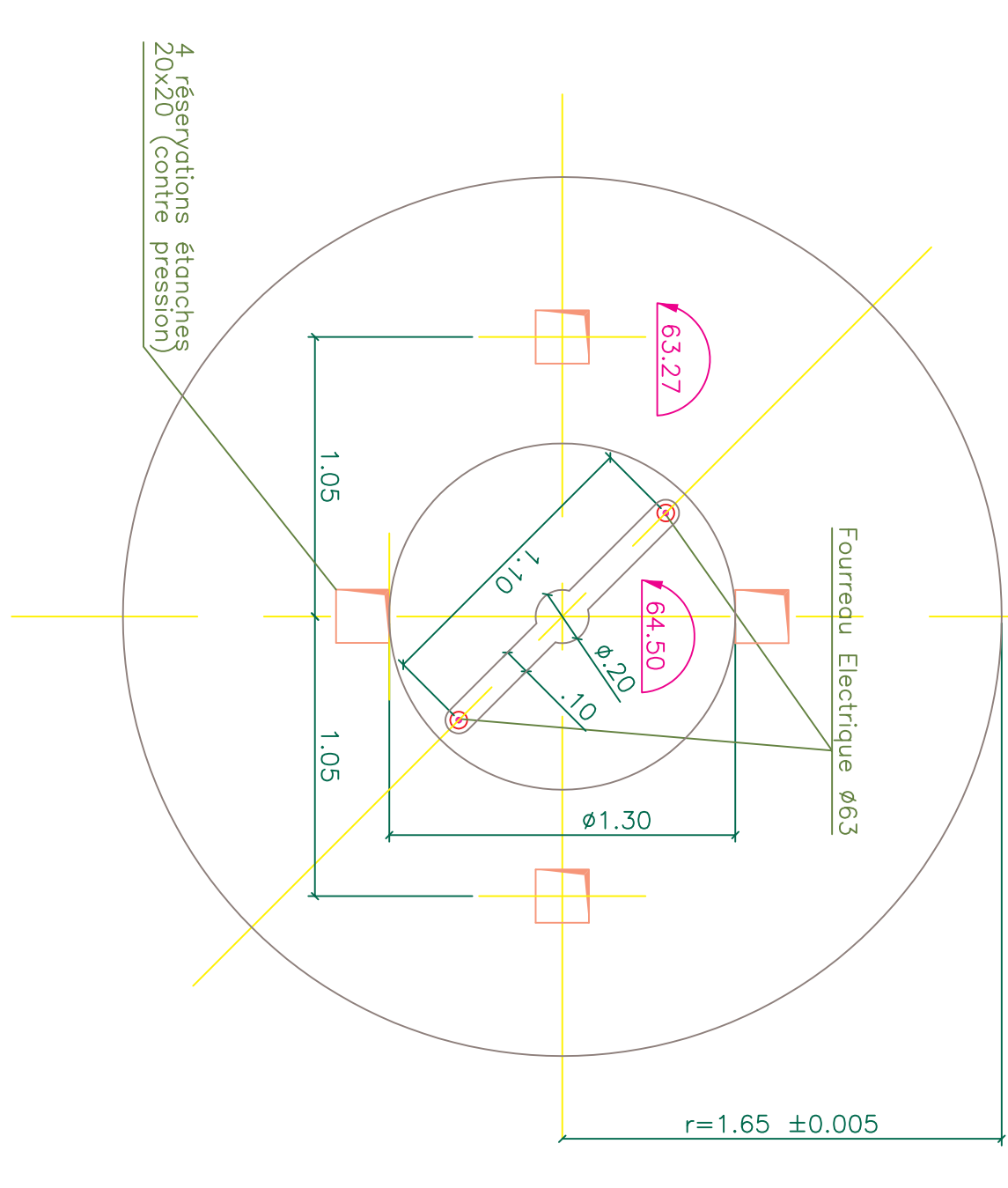

**VUE EN PLAN**  
Echelle: 1/50

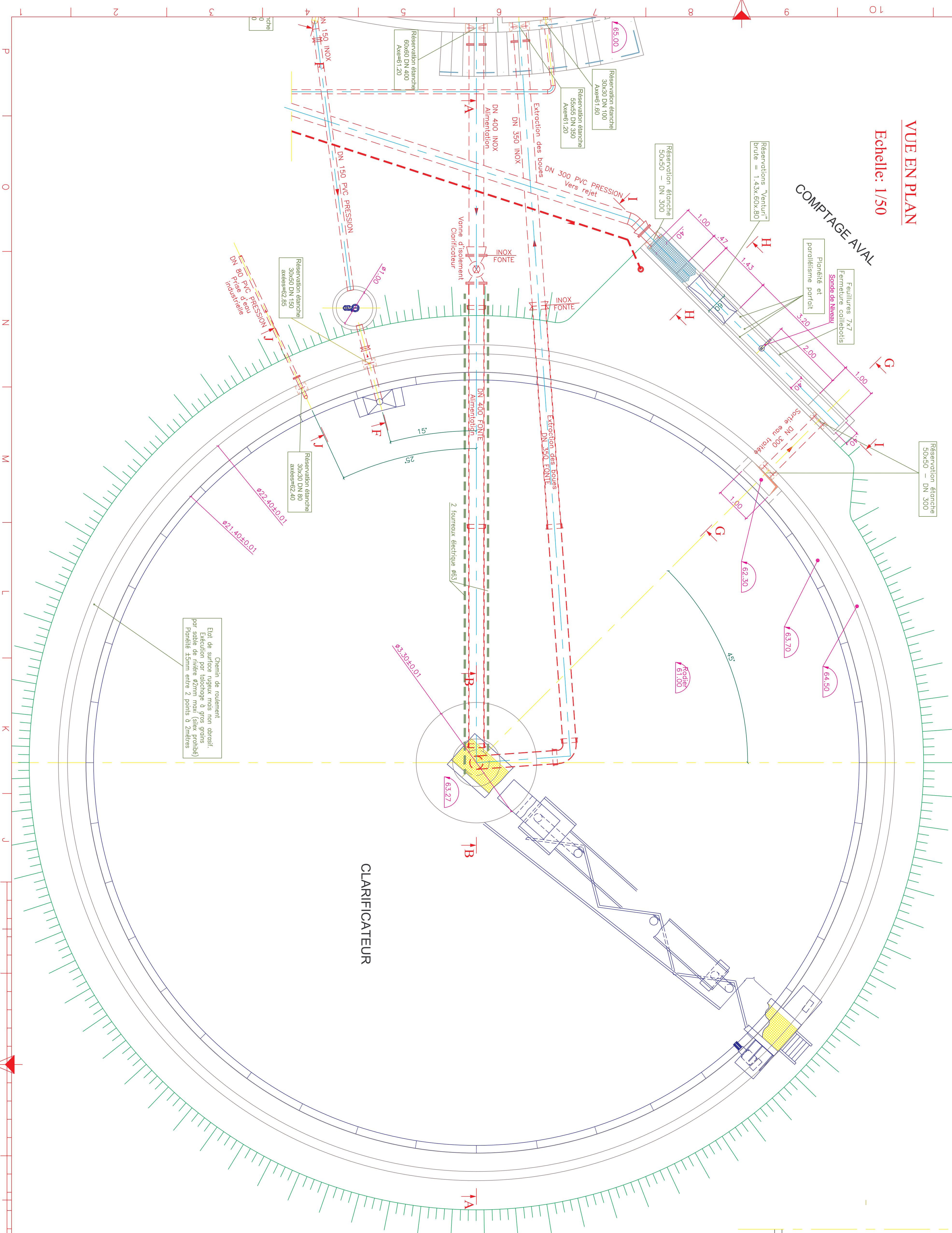

**COUPE GG**  
Echelle: 1/50

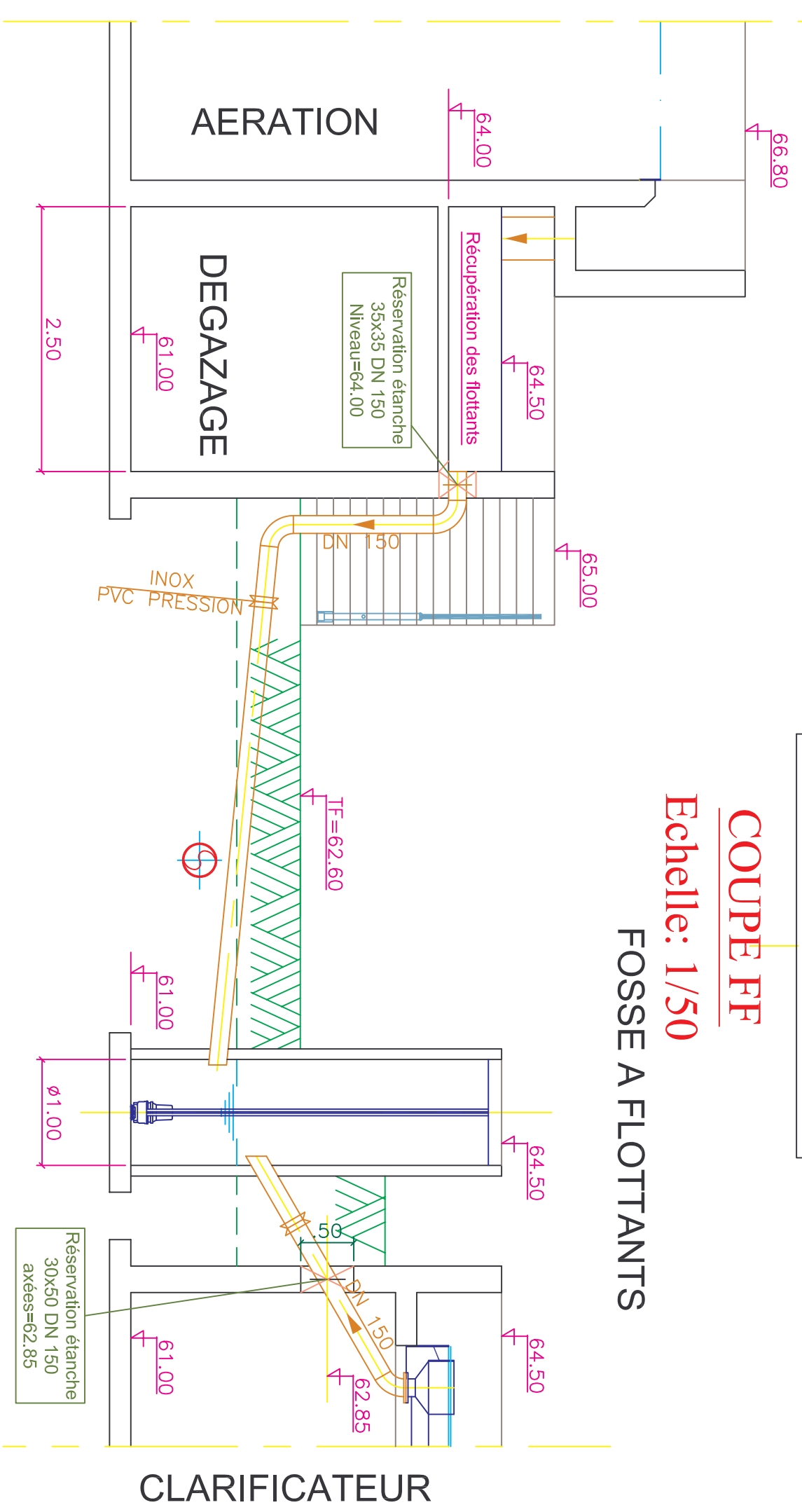

**COUPE JJ**  
Echelle: 1/50

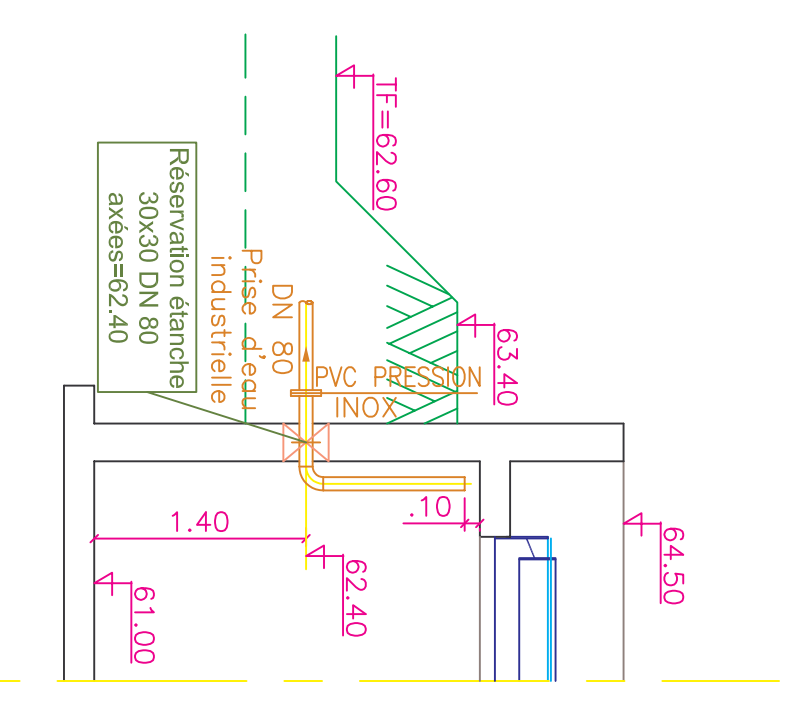

**COUPE HH**  
Echelle: 1/50

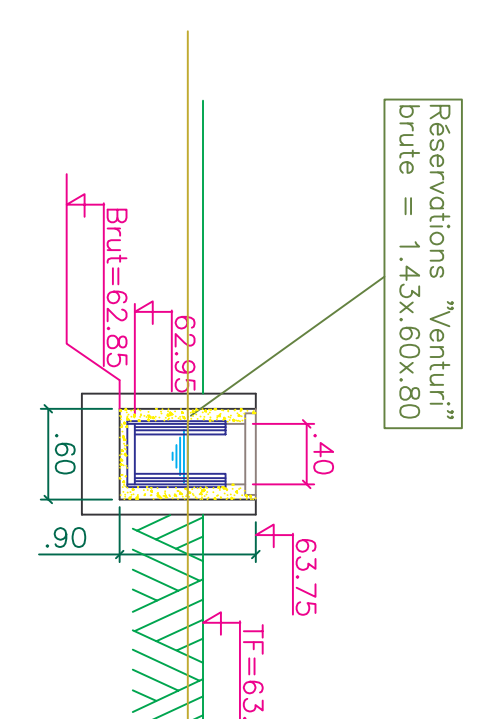

**COUPE II**  
Echelle: 1/50

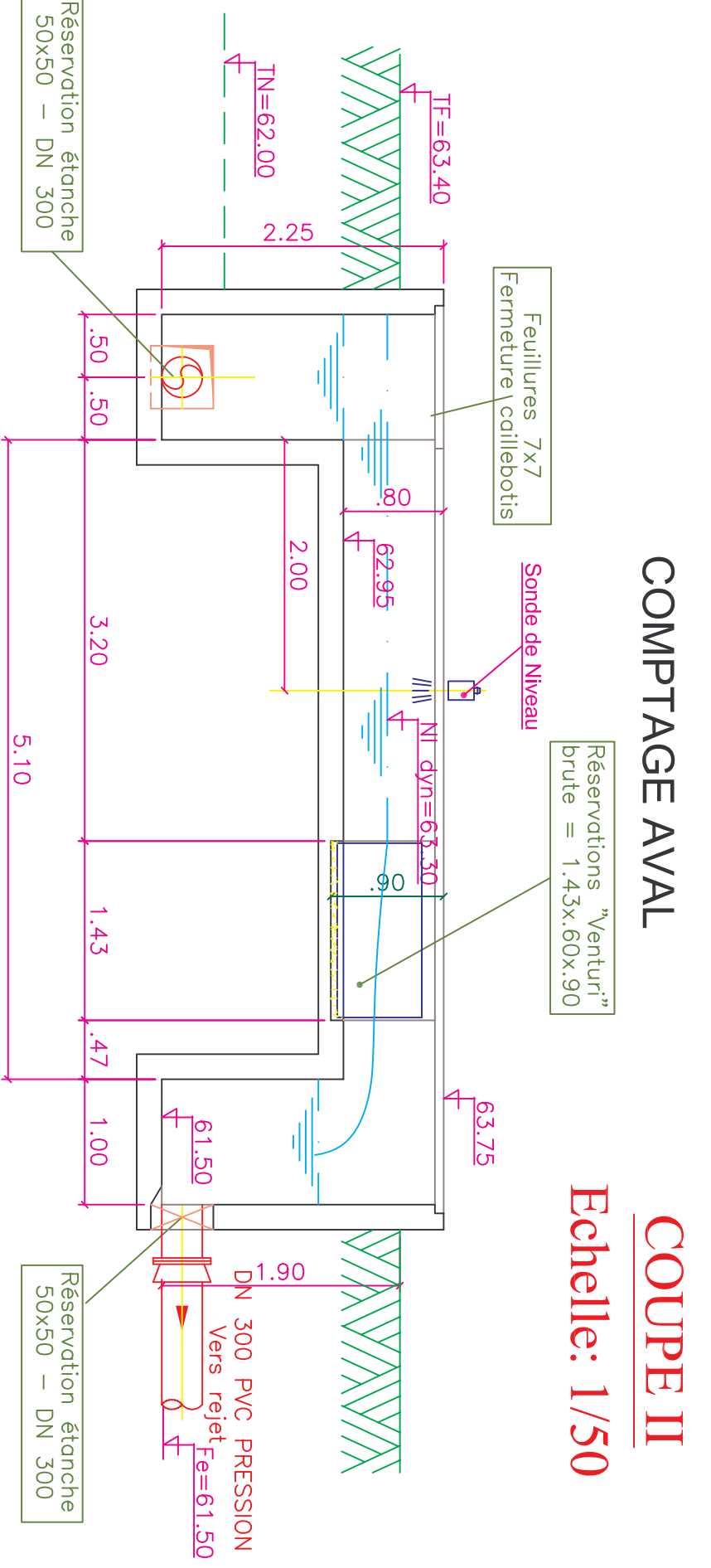

**CONSTRUCTION DE LA STATION DEPURATION**

**CLARIFICATEUR**  
FOSSÉ A FLOTTANTS  
CANAL DE COMPTAGE

Plans de Récollement

EA  
Echelle: 1/50

Conception / Réalisation

**ZA de Morvillan**  
10150 VALILLY  
Tel: 03-25-44-22-22  
Fax: 03-25-44-53-19

**Ville de NOGENT**  
Sur-Seine

**Aube**  
Cavalier Général

**SAU**  
Cavalier Général

**CT 47/8**

**SOG ENS RE B 007**